



## LEGAL NOTICE

AND

## INVITATION TO BID B #042-24

The Brownsville Public Utilities Board will accept sealed bids for Supply of 225 KVA, 3-Phase Padmount Transformers, **until 5:00 PM, May 1, 2024** in the Brownsville PUB Purchasing Office, 1155 FM 511, Olmito, Texas. **Bids received after this time will not be considered.**

Bids will be publicly opened and read aloud on May 2, 2024 at 10:30 AM. Bidders can request a copy of the bid tabulation by emailing [hlopez@brownsville-pub.com](mailto:hlopez@brownsville-pub.com). Vendors can call in at 10:30 AM, May 2, 2024 to (956) 214-6020 to listen to the bid opening.

Detailed specifications may be obtained at Brownsville Public Utilities Board website at [https://www.brownsville-pub.com/rfp\\_status/open/](https://www.brownsville-pub.com/rfp_status/open/).

Please mark on the **outside of the envelope and on any carrier's envelopes: "SEALED BIDS FOR SUPPLY OF 225 KVA, 3-PHASE PADMOUNT TRANSFORMERS (B042-24), MAY 1, 2024 5:00 PM"**, and send to the attention of Diane Solitaire, Purchasing Department, 1155 FM 511, Olmito, TX 78575.

The Brownsville Public Utilities Board will not be responsible in the event that the U.S. Postal Service or any other courier system fails to deliver the sealed bids to the Brownsville Public Utilities Board, Purchasing Office by the given deadline above. **No bid will be accepted via electronic transmission or facsimile.**

The Brownsville PUB reserves the right to reject any or all bids and to waive irregularities contained therein and to accept any bid deemed most advantageous to the Brownsville PUB.

BY:

*Diane Solitaire*

Purchasing

(956) 983-6366 - Phone

Please submit this page upon receipt.

**ACKNOWLEDGEMENT FORM**

B#042-24 Supply of 225 KVA, 3-Phase Padmount Transformers

For any clarifications, please contact Hugo E. Lopez at the Brownsville Public Utilities Board, Purchasing Department at (956) 983-6375 or (956) 983-6364 or via e-mail: [hlopez@brownsville-pub.com](mailto:hlopez@brownsville-pub.com)

Please e-mail this page upon receipt of legal notice. If you only received the legal notice and you want the bid package mailed, please provide a method of shipment with account number in the space designated below.

Check one:

**Yes, I will be able to send a bid; obtained bid package from website.**

**Yes, I will be able to send a bid; please email the bid package.**

Email: \_\_\_\_\_

**Yes, I will be able to send a bid; please mail the bid package using the carrier & account number listed below:**

Carrier: \_\_\_\_\_

Account: \_\_\_\_\_

**No, I will not be able to send a bid for the following reason:**

\_\_\_\_\_  
\_\_\_\_\_

If you are unable to send your bid, kindly indicate your reason for “No bid” above and return this form **via e-mail to:** [hlopez@brownsville-pub.com](mailto:hlopez@brownsville-pub.com) or [dsolitaire@brownsville-pub.com](mailto:dsolitaire@brownsville-pub.com). This will ensure you remain active on our vendor list.

Date \_\_\_\_\_

Company: \_\_\_\_\_

Name: \_\_\_\_\_

Address: \_\_\_\_\_

City: \_\_\_\_\_ State: \_\_\_\_\_ Zip Code: \_\_\_\_\_

Phone: \_\_\_\_\_ E-mail: \_\_\_\_\_

Email: \_\_\_\_\_

**IF SPECIFICATIONS ARE DOWNLOADED FROM WEBSITE PLEASE EMAIL THIS PAGE TO EMAIL LISTED ABOVE**

## Special Instructions

### *Contract Information*

- **Interpretation**

Questions concerning terms, conditions, and technical specifications should be directed to:

Hugo E. Lopez,  
Purchasing Administrator  
(956) 983-6375

or

Diane Solitaire, Purchasing & Materials  
Manager, (956) 983-6366

- **Tentative Time Line**

1. April 15, 2024 to May 1, 2024 - Vendors work on bid.
2. May 1, 2024 at 5:00 PM CST - Vendor must submit one set of the bid documents sealed in an envelope to:

Diane Solitaire, Purchasing  
1155 FM 511  
Olmito, Texas 78575

Bid #042-24 –Supply of 225 KVA, 3-Phase Padmount Transformers

Due: **May 1, 2024 at 5:00 PM**

*The above noted information must be included on bid envelope and on any carrier's envelope/package. The Brownsville Public Utilities Board **will not be held responsible for missing, lost or late mail.** Brownsville Public Utilities Board will not accept facsimile or electronic transmission of sealed bids.*

3. April 24, 2024 – Last Day to submit Questions
4. May 2, 2024 - Open bids at 10:30 AM
5. May 3-24, 2024 - Evaluate bids
6. May 27, 2024 – Provide Final Recommendations
6. June 10, 2024 - Send to Utilities Board for approval
7. Term of contract will commence – June 2024

- **Or Equal**

Brand name or manufacturer's reference used in this request is descriptive – not restrictive – it is intended to indicate type and quality desired. Brands of like nature and quality will be considered. If bidding on other than referenced specifications please provide complete descriptive information of said article.

- **Pricing**

Bid unit price on quantity specified, extend and show total. In case of errors in extension, unit prices shall govern. **Price shall remain firm until an award is made and after original date of Purchase Order, unless otherwise stipulated.**

All fields (UNIT PRICE, TOTAL PRICE, & EST DELIVERY IN DAY) in the specifications pages must be filled. The data must be complete to identify the bidding brand.

*Failure to submit any of the above information with the sealed bid will disqualify bid.*

- **Vendor Representative**

The successful vendor agrees to send a personal representative with binding authority for the company to the Brownsville Public Utilities Board upon request to make adjustments and/or assist with coordination of all transactions as needed.

- **Quality of Products**

All items must be new, in first class condition, including containers suitable for shipment and storage. No substitutions in standard grades or lesser quality will be accepted.

- **Determining Factors for Award**

1. **Delivery/Lead Time is of the utmost importance**
2. Total Evaluated Cost (TEC=Bid Price+NLLC+LLC)
3. Stock Availability
4. Reputation of the Bidder
5. Reputation of brand names offered
6. BPUB financial and legal responsibility evaluations of any identified teaming arrangements involving significant joint ventures, subcontractors and suppliers

- **Contract with Vendor/Entity Indebted to BPUB**

It is a policy of the BPUB to refuse to enter into a contract or other transaction with an individual, sole proprietorship, joint venture, Limited Liability Company or other entity indebted to BPUB.

- **Vendor ACH (Direct Deposit) Services**

BPUB has implemented a payment service for vendors by depositing the payment directly to the vendor's bank account. Successful vendor(s) will be required to receive payments directly through Automated Clearing House (ACH) in lieu of a paper check. **The awarded vendor must agree to receive payments via ACH (Direct Deposit).**

- **Tax Identification Number (TIN)**

In accordance with IRS Publication 1220, aW9 form, or a W8 form in cases of a foreign vendor, will be required of all vendors doing business with the Brownsville PUB. If a W9 or W8 form is not made available to Brownsville PUB, the first payment will be subject to income tax withholding at a rate of 28% or 30% depending on the U.S. status and the source of income as per IRS Publication 1220. **The W9 or W8 form must be included with bid response.** Attached are sample forms.

- **Taxes**

The Brownsville Public Utilities Board is exempt from Federal Excise Tax, State Tax and local Taxes. Do not include tax in the bid. If it is determined that tax was included in the bid it will not be included in the tabulation or any awards. Tax exemption certificates will be furnished upon request.

- **Signing of Bid**

**Failure to sign bid will disqualify it.** Person signing bid should show title or authority to bind their firm to a contract.

- **EEOC Guidelines**

During the performance of this contract, the contractor agrees not to discriminate against any employee or applicant for employment because of race, national origin, age, religion, gender, marital or veteran status, or physically challenging condition.

- **As Needed Basis (Reserved)**

Quantities are to be released on an “as needed” basis and be billed as such. However, successful vendor must keep in stock one (1) release, if requested in bid, for immediate shipment to the BPUB. Brownsville PUB will not accept the full quantity at one time as specified on Cost Sheet.

- **Contract and Purchase Order**

The transformers shall be delivered FOB Brownsville Public Utilities Board, 1155 FM511, Olmito,, TX 78575, via flat-bed open trailer. Transformers shipped in an enclosed trailer will be rejected upon delivery. A contract for the transformers will be placed into effect by means of a purchase order issued by the Brownsville Public Utilities Board after tabulation and final approval by the Board.

- **Brownsville Public Utilities Board Rights**

1. If only one or no bid is received by "submission date", the BPUB has the right to reject, re-bid, accept and/or extend the bid by up to an additional two (2) weeks from original submission date.

2. The right to reject any/or all bids and to make award as they may appear to be advantageous to the Brownsville Public Utilities Board.
3. The right to hold bid for 90 days from submission date without action, and to waive all formalities in bid.
4. The right to extend the total bid beyond the original 90 days period prior to an award, if agreed upon in writing by all parties (BPUB and vendor/contractor) and if bidder/vendor holds original bid prices firm.
5. The right to terminate for cause or convenience all or any part of the unfinished portion of the Project resulting from this solicitation within Thirty (30) calendar days written notice; for cause: upon default by the vendor/contractor, for delay or non-performance by the vendor/contractor; or if it is deemed in the best interest of the BPUB for BPUB's convenience.
6. The right to increase or decrease quantities. In bid, stipulate whether an increase or decrease in quantities will affect bid price
7. The Brownsville PUB has the right to refuse to enter into a contract or other transaction with any individual or entity indebted to the municipality as per Local Government Code 252.0436.

- **Corrections**

Any interpretation, correction, or change to the invitation to bid will be made by ADDENDUM. Changes or corrections will be issued by the Brownsville PUB Purchasing Department. **Addenda will be emailed to all who have returned the Bid Acknowledgment form.** Addenda will be issued as expeditiously as possible. It is the responsibility of the vendors to determine whether all addenda have been received. It will be the responsibility of all respondents to contact the Brownsville PUB prior to submitting a response to the invitation to bid to ascertain if any addenda have been issued, and to obtain any all addenda, execute them, and return addenda with the response to the invitation to bid. Addenda may be posted on the Brownsville PUB's website.

### **REFERENCE CHECKS**

The BPUB will contact prospective firm's references by email or telephone. **Complete the attached "Previous Customer Reference Worksheet" for each reference provided.**

**COST SHEET  
B042-24**

Note: THREE PHASE with **304 stainless steel enclosure (tank, lid, cabinet) Padmount Transformers.** All specifications and dimensions will remain the same.

ITEM #	QTY	DESCRIPTION	UNIT PRICE 304 STAINLESS STEEL TRANSFORMERS	EXTENDED TOTAL	DELIVERY IN DAYS (ARO)
<b>PADMOUNT, THREE PHASE</b>					
1	5 each	(E1524-00) TRANSFORMER 225 KVA 7200 120/208 PADMOUNT THREE PHASE WITH TAP CHANGER +/- 2.5% AND WITH INTERNAL FAULT DETECTOR  NL:            LL:            TL:			

**Note:** The transformers shall be delivered FOB Brownsville Public Utilities Board, 1155 FM 511, Olmito, Texas 78575 **via open/flatbed trailer. Transformers shipped in an enclosed trailer will be rejected upon delivery.**

**Special Instructions:**

Price shall remain firm for a 6 weeks period after original date of Purchase Order.  
Put a “√” checkmark here: (    ), if able to keep price firm for a 90 days period.  
If not, indicate length of time: \_\_\_\_\_.

**Transformers shipped in an enclosed trailer will be rejected upon delivery.**

Brownsville PUB has the right to increase or decrease quantities. In space below, stipulate whether the increase or decrease will affect bid price.

(\_\_\_\_) Yes, an increase or decrease in quantity affects bid price.

(\_\_\_\_) No, an increase or decrease in quantity will not affect bid price.

**SPECIFY MANUFACTURER:** \_\_\_\_\_

Company Name: \_\_\_\_\_

Company Address: \_\_\_\_\_

Authorized Company Representative: \_\_\_\_\_

Authorized Company Representative: \_\_\_\_\_

**Signature – Failure to sign Bid will disqualify it**

Company Address: \_\_\_\_\_

\_\_\_\_\_

Telephone #: \_\_\_\_\_

Fax #: \_\_\_\_\_

E-mail: \_\_\_\_\_



**BROWNSVILLE PUBLIC UTILITIES BOARD  
SPECIFICATIONS FOR **THREE PHASE**  
PADMOUNTED DISTRIBUTION TRANSFORMERS  
45 KVA THROUGH 2500 KVA**

1.0 GENERAL

- 1.01 This specification covers the electrical characteristics and mechanical features of three phase, 60 Hertz, wye-wye or wye-delta (as specified) connected, mineral oil immersed, self-cooled, padmounted compartmental type transformers, rated 45 kVA through 2500 kVA @65°C temperature rise above ambient.
- 1.02 All characteristics, definitions, and terminology, except as specifically covered in this specification shall be in accordance with the latest revision of the NEMA, IEEE, ANSI and IEEE standards and in particular C57.12.00, C57.12.10, C57.12.22, C57.12.26, C57.12.28, C57.12.70, C57.12.80, C57.12.90.
- 1.03 Purchase Order Contract will be issued for the 3 Phase Padmount transformers.
- 1.04 Transformers will be ordered in releases as required to maintain a 90 day supply in the Brownsville PUB stock (**NOT APPLICABLE**).
- 1.05 Only the transformers as ordered, delivered and accepted will become due for payment. Brownsville PUB contemplates ordering the full amount on cost sheet.
- 1.06 Quantities indicated on the bid pricing sheet (attached) are estimated, based on usage history, and may vary by + or — 10%. The Brownsville PUB reserves the right to increase or decrease quantities as deemed necessary.
- 1.07 Bidders are asked to hold price firm for 90 days from submission date as per BPUB's Rights on Page 6. All prices shall remain firm for six (6) months after date of Purchase Order and must be shipped **FOB Brownsville PUB Warehouse, 1155 FM 511, Olmito, TX 78575**.
- 1.08 Notification of Delivery: The Warehouse Administrator shall be notified at (956) 983-6181 or at (956) 983-6369 of the intended delivery forty-eight (48) hours prior to the actual delivery to the designated location, in order that the Owner's personnel and equipment may be available to accept delivery.
- 1.09 Delivery of transformers will only be accepted when delivered via an open trailer and during normal working hours, Monday thru Friday from 8:00 AM to 4:00 PM. Transformers being delivered in an enclosed trailer will be rejected. A delivery ticket must be furnished with each delivery by the carrier. The delivery ticket must show the BPUB's Purchase Order, number of crates, packages, etc. being delivered to the Owner. A packing list must be furnished with each delivery by the carrier. The packing list must include the BPUB's Purchase Order number, a description and the total number of transformers, size, etc. being delivered to BPUB.
- 1.10 The Brownsville PUB reserves the right to refuse to accept any transformer not meeting these specifications or at its option to deduct a 10% discount on such units.
- 1.11 Substitute items must be approved by the BPUB prior to shipment.
- 1.12 All transformers must have the WARNING LABEL meeting the latest version of ANSI Standards/Rules.

2.0 **INSULATION LEVEL**

2.01 The high voltage insulation shall be:

<u>Rated High Voltage (Volts)</u>	<u>BIL (kV)</u>	<u>Insulation (kV)</u>
12470 GY/7200	95	15
12470 Y/7200	95	15

2.02 The low voltage insulation level shall be as follows:

<u>Low Voltage Rating (Volts) (kV)</u>	<u>BIL (kV)</u>	<u>Insulation</u>
208Y/120	30	1.2
480Y/277	30	1.2
240Δ/120	30	1.2
2400Δ	45	2.5

3.0 **HIGH VOLTAGE TAPS**

3.01 All ratings shall be provided with high voltage taps as shown below:

<u>Low Voltage Rating</u>	<u>KVA</u>	<u>Above and/or Below Rated Voltage</u>
208Y/120	All	Two 2 ½% above, Two 2 ½% below
480Y/277	All	Two 2 ½% above, Two 2 ½% below
240Δ/120	All	Two 2 ½% above, Two 2 ½% below
2400Δ	All	Two 2 ½% above, Two 2 ½% below

The tap changer handle shall be mounted for external operation and located in the high voltage compartment. Handle shall be shot gun stick operable. Mechanism shall be rated at 200 continuous load for 45 KVA through 1000 KVA and 150% continuous loading for 1500 KVA and higher.

4.0 **TEMPERATURE RISE LIMITS**

4.01 The transformer shall be provided with a five legged core or a triplex design so that excessive tank heating will not occur during unbalanced loading conditions or loss of one phase.

4.02 The winding rise above ambient temperature shall not exceed 65°C when tested in accordance with the ratings.

4.03 The hot spot temperature rise above ambient temperature shall not exceed 80°C when tested in accordance with their ratings.

5.0 **IMPEDANCE**

5.01 The percent impedance voltage as measured on the rated voltage connection shall be as follows:

<u>KVA Rating</u>	<u>Impedance</u>
45-500	2.0% - 5.0%
750-2500	5.75% ± 7.5%

6.0 **TESTING**

6.01 The manufacturer shall perform the following tests on 100% of the units supplied. The testing shall be in accordance with ANSI C57.12.90.

Ratio  
Polarity  
Exciting Current  
Impedance  
No-Load (Core) Losses  
Induced Potential (Over-Excitation)  
Applied Potential (Primary and Secondary)  
Leak Test

6.02 Certified test reports shall be provided by serial number on each unit shipped. The reports shall contain, as a minimum, the following information:

Percent Impedance  
Percent Exciting Current  
No-Load Loss @ 85°C  
Load Loss @85°C  
Total Loss @85°C  
Induced Potential Certification  
Applied Potential Certification  
Oil Certification Per Par. 7.00

7.0 **OIL**

The liquid supplied in these transformers shall be non-PCB type, as defined by Federal Regulation No. 40CFR 761, dated May 31, 1979. The liquid contained in these transformers shall be identified as a non-PCB type containing less than 2 ppm. The data shall be on the nameplate on the transformer.

8.0 **CONSTRUCTION**

8.01 **Core and Coil Construction**

The transformer coils shall be designed to maintain their nameplate KVA rating throughout the temperature range. All materials used shall be of the 65°C (80°C Hot Spot) Class and be thoroughly tested for compatibility with all transformer components before inserted into design. Only thermally upgraded, one hundred percent conduction particle tested Kraft paper shall be used for secondary layer insulation. Provision shall be provided to securing sheet windings and also the primary winding in their position during construction and also short circuit conditions. Either diamond pattern, thermal setting adhesive type paper or cuffing of the insulation is acceptable.

Oil ducts shall be strong enough to withstand full short circuit forces. Fiber pressboard ducts or processed hardwood maple sticks shall be used for the oil ducts. No other material will be accepted.

The cores shall be manufactured from grain oriented silicon steel laminations, coated with a glass-hard insulation to prevent sheet-to-sheet shortings and shall be deburred before forming into final shape. The cores shall be fully annealed or stacked design to relieve stresses incurred during manufacturing process.

#### 8.011 Core-Coil Assembly

The core and coil, after assembly, shall be mounted in a rigid steel frame, constructed in such a way as to hold the coil in a rigid position within the core window without placing undue stress on the core or short circuit the laminations at any point. No wood other than processed hardwood maple shall be used in core-coil assembly and then only in proper ratio with other materials.

#### 8.02 General

8.021 The padmounted compartmental type transformers shall consist of the transformer tank and compartment shall be assembled as an integral unit. The transformer doors and compartments shall be constructed in accordance with ANSI C57.12.28, latest revision.

8.022 Transformers shall be furnished without clam-shell doors, flip top door, or any doors without stainless steel hinges.

8.023 All exterior nuts and bolts shall be of a corrosion resistant material.

8.024 The unit shall be painted Munsell #7GY 3.29/1.5 Green. Paint shall be of such quality so that it will conform to the latest revision of the EEI Finishing Guidelines for Padmounted Equipment. Provide prices (optional) for this type of coating: Amerlock II Series 400 epoxy based premier at least 5 mils thick with a topcoat of PPG's PSX 1001 Series single pack acrylic polysiloxane at least 3 mils thick for color retention (Option I on Cost Sheet).

8.025 All transformers must have a reflective decal displaying the KVA of the transformer on the front. Decal shall be no more than 2 ½" x 4", Scotchlite Brand Reflective Sheeting.

#### 8.03 Bushings and Terminals

8.031 The bushings and terminals shall be located in accordance with Figures 6, 7, and 8A of ANSI C57.12.26, latest revision.

8.032 The transformer shall be provided with six high voltage bushing wells (ANSI/IEEE 386, latest revision), externally clamped, and with 8 parking stands to permit operating the transformer from a looped primary system. High voltage lead lengths shall be of such lengths as to permit field replacement of bushing wells (RTE Part #2603973B01 or pre-approved equal). On wye-delta transformers, Ho connection will be internal only, not brought out on a bushing.

8.033 Parking stands shall be located in accordance with Figure 6 of ANSI C57.12.26, latest revision.

8.034 Low voltage line and neutral bushings shall be fully insulated externally clamped copper Spades. The spade bushing shall be integral in construction with: a six-hole terminal on 500 KVA and below transformers; a 12-hole terminal on 750 KVA and above transformers. All terminals shall be in tin plated copper and conform to Fig. 9b on ANSI C57.12.26. All spades shall be supported with external insulated brackets to relieve stress on low voltage bushings and gaskets, as per attached Fig. 1.

8.035 The low voltage neutral bushing shall be an insulated bushing with the removable external Ground connection. The ground strap shall be adequate to carry the fault current based on the rating of the transformer.

#### 8.04 Internal Bushing Leads

8.041 High voltage bushing leads shall be trained and appropriately insulated to avoid dielectric breakdown between adjacent cables. Spacers, permanently held in place, should be used to prevent cables from failing phase to phase or phase to ground.

8.042 Low voltage bushing leads made of aluminum shall be welded in place using a gas metal arc welding process. The use of a welding technique similar to one known as “the fore-hand and vertical-up technique” will eliminate porosity of the weld head. This will create a good electrical and strong (mechanical) connection. Low voltage bushing leads made of copper shall be “brazed” together or cold welded.

8.05 Fusing

8.051 The transformers shall be equipped with three Bay-O-Net draw-out use holders and expulsion fuses. See attached fuse table.

8.052 Bay-O-Net fuse holder assembly shall be placed so that the fuses may be removed by a Person using hot stick without having to raise or remove the primary compartment cover.

8.053 An oil drip shield (metal) shall be furnished directly beneath the Bay-O-Net fuse.

8.06.1 High Voltage & Low Voltage Compartments

8.061 Doors on the high voltage and low voltage compartments shall be of sufficient size to provide adequate working space when opened.

8.062 With the low voltage compartment door opened or removed, the high voltage shall be protected by adequate safeguards. Access to the high voltage compartment shall not be attained until some specific action is taken, such as releasing a pentahead bolt to allow the compartment door to be opened. The barrier separating the two compartments shall be of such material which would retain its rigidity over the life of the unit. If an insulating material is used for the barrier, it shall be supported or braced on all sides with metal strips.

8.07 Switching

8.071 A three phase gang operated four position under oil loadbreak switch shall be supplied on all transformers (see drawing on page 34). The switch shall have a loadbreak rating of 600 amperes and a 3-shot make and latch rating of 10,000 amperes symmetrical. The connections to be made in each switching position are as follows:

Position 1: Source A, Source B, Transformer Coils

Position 2: Source A, Transformer Coils

Position 3: Source B, Transformer Coils

Position 4: Source A, Source B, Coils Disconnected

The switch handle, located in the primary compartment, shall be capable of being operated with a hot stick. The switch is to be RTE part #220913C61M or approved equivalent.

8.08 Accessory Equipment

8.081 The following equipment and devices shall be provided on 500 KVA and larger units:

- 1) Oil drain valve with sampling device located in the high voltage compartment.
- 2) Liquid level gauge in low voltage compartment.
- 3) Temperature indicator in low voltage compartment.

8.082 The transformer shall be supplied with a pressure relief device located on the low voltage side of the terminal compartment. The device shall be capable of automatically venting 50 scfm @ 15 psi. The operating pressure shall be  $10 \pm 1$  psi with reseal at  $8 \pm 1$  psi.

8.09 Handling and Mounting Facilities

8.091 Rolling provision. The transformer base shall be arranged for rolling in two directions parallel to and at right angles to the centerline of the high voltage bushings.

- 8.092 Lifting provision shall be in accordance with ANSI C57.12.26.
- 8.93 Mounting provision. The base of the assembly shall be provided with a suitable flange to permit anchoring the unit on the pad from within the cable terminating compartments.

8.10 Terminal Marking and Angular Displacement

- 8.101 Terminal designations shall be defined by American National Standard C57.12.70, Terminal Markings for Electrical Apparatus, with each terminal clearly marked with oil resistant yellow paint.
- 8.102 The identification of terminal connections shall be shown on the instruction nameplate.
- 8.103 The angular displacement between the high and low voltage windings on wye-delta units shall be thirty degrees.

8.11 Instruction Nameplate

- 8.111 The instruction nameplate shall be located at a convenient spot on the inside of the low voltage compartment and shall be readable with cables in place.
- 8.112 The information specified in Table 7 (nameplate B) of ANSI Standard C57.12.00, latest revision thereof, shall be permanently shown on the instruction nameplate.
- 8.113 The nameplate shall be made of a corrosion resistant material.
- 8.114 The nameplate shall show the type of material in the HV and LV coils.
- 8.115 The nameplate shall show the PCB content to be less than 2 ppm.
- 8.116 Manufacturer needs to provide actual PCB concentration of mineral oil on the **NAMEPLATE**. Simply labeling transformers **Non-PCB** is not sufficient, actual concentration needed (i.e. <1 ppm PCB).
- 8.117 Manufacturer needs to provide certification indicating the concentration of PCBs in their transformers.

8.12 Oil Preservation

- 8.121 A sealed tank system shall be standard on all transformers.
- 8.122 A sealed tank system is one in which the interior of the transformer will be sealed from the atmosphere throughout its top oil temperature range, and in which the gas plus the oil volume remain constant. The transformers will remain effectively sealed throughout a top oil temperature range of -5°C to +105°C provided the initial level has been properly adjusted.

8.13 Tanks

- 8.131 The tank shall be of sufficient strength to withstand a pressure of 7 psi gauge, without permanent distortion. A 1” pipe plug for filling and pressure testing shall be provided.

- 8.132 Tank covers may be either the bolted-on or welded-on type. The bolted-on cover shall have provisions to make it tamperproof or tamper resistance. The weld-on cover shall have an access hole which has an opening of sufficient size to permit removal of core/coil assembly as a unit. The access hole shall have a bolted-on cover with a tamperproof false cover over it.
- 8.133 Tank grounding shall be in accordance with ANSI Standard C57.12.26.

9.0 OTHER

- 9.01 No deviation from these specifications on the part of the bidder will be accepted unless approved in writing prior to submission of bid. Any items supplied under these specifications not in complete compliance with these specifications shall be unacceptable and returned to the vendor at the vendor's expense.
- 9.02 The manufacturer must have on file with the BPUB approved drawings or shall submit detail manufacturing drawings to the BPUB Purchasing Department for approval of each size transformer to be supplied under this specification. Revision to these drawings must be approved prior to delivery of any transformer not conforming to accepted drawings.
- 9.03 Notification of any changes in the manufacturing process, materials or component parts shall be provided by the vendor and approved by the BPUB **prior** to delivery of any units. Both the notification and approval must be in writing to:
- Transmission & Distribution Division, Eli Alvarez/James McCann, Brownsville PUB,  
1425 Robinhood Drive, Brownsville, Texas 78521 (956) 983-6234/983-6204.
- 9.04 All manufacturers furnishing transformers under these specifications shall supply at least 5% of the distribution transformer market and have at least 10 years experience in the manufacture and sales of distribution transformers.
- 9.05 Any transformers furnished not meeting these specifications will be returned to the vendor at the vendor's expense. In the event BPUB chooses to use those units because of its needs, it will deduct 10% of the purchase price as liquidated damages, in addition to any other expenses it incurs to make the unit useable.
- 9.06 Approval drawings (mfg.) are required on any specification changes.

BROWNSVILLE PUBLIC UTILITIES BOARD SPECIFICATION  
PADMOUNT TRANSFORMER FUSING

<u>Transformer Size (KVA)</u>	<u>Bay-O-Net Fuse Rte. Cat. No.</u>
45	4000358C03
75	4000358C05
112.5	4000358C08
150	4000358C08
225	4000358C10
300	4000358C10
500	4000358C12
750	4000358C14
1000	4000358C14
1500	4000353C17
2000	4000353C17
2500	4000353C17



## CERTIFICATION OF COMPLIANCE

Vendors shall supply, prior to bidding, certified test results to qualify the quality of the product being supplied for approval.

1. Cabinet security test per Western Underground Committee Guide 2.13/04/0279.
2. Proof of compliance with latest revision of the EEI Finishing Guidelines for Padmounted Equipment.
3. Short Circuit Testing:

The manufacturer shall supply certified test reports to verify that their design has passed short circuit criteria per ANSI C57.12.00 and ANSI C57.12.90, latest revision. The written report shall include pretest impedance, post test impedance, percent change, identification of unit tested and the date of the test. **The certified test report must reference Brownsville PUB Purchase Order Number.**

Send one set of the certified test reports to each department as noted below and referenced the bid number.

Electrical Engineering Department      and  
Brownsville PUB  
1425 Robinhood Drive  
Brownsville, Texas 78521

Purchasing Department  
Brownsville PUB Warehouse  
1155 FM 511  
Olmito, Texas 78575

**DRAWING N°1**

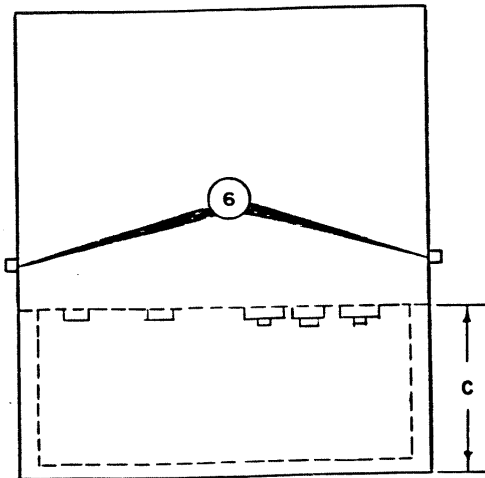
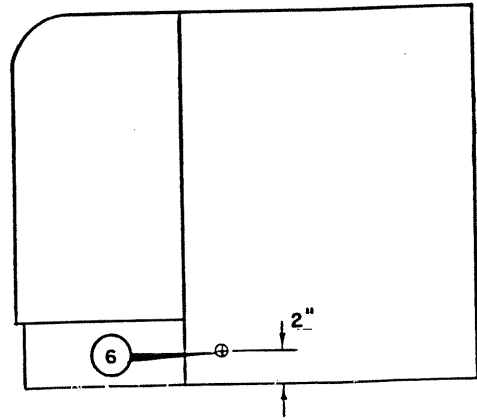
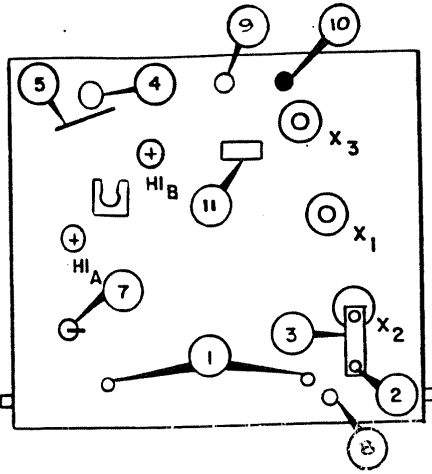

- ① TANK GROUNDING TERMINALS —
- ② X2 GROUND BOSS
- ③ X2 GROUNDING STRAP —
- ④ BAYONET FUSEHOLDER
- ⑤ OIL DRIP SHIELD
- ⑥ GROUND BOSSES
- ⑦ TAP CHANGER
- ⑧ OIL DRAIN PLUG
- ⑨ OIL FILL PLUG
- ⑩ PRESSURE RELIEF DEVICE
- ⑪ NAMEPLATE

1Ø PAD MOUNTED DEAD FRONT  
TRANSFORMER ANSI TYPE-II

Public Utilities Board



P.O. Box 3270  
Brownsville, Texas  
78820

1	1/85	P.V.	ANSI-I TO ANSI-II
2	5/95	S.G.	ADD ITEM 8-11
REV	DATE	BY	SUBJECT

**ELECTRIC ENGINEERING DEPT**

DRAWN BY: *PL* APPROVED BY: *Y.C.C.*

DATE: 4-25-83 SCALE: *N/A*

DRAWING NUMBER: SHEET NUMBER: 1

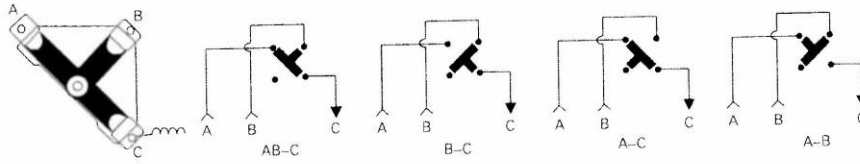

Figure 27. T-blade switch function.

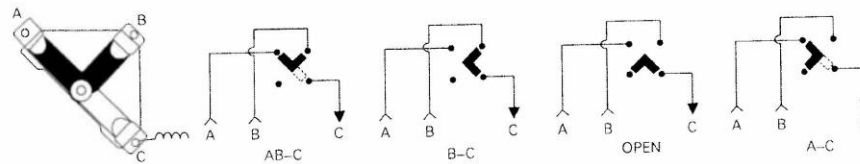



Figure 28. V-blade switch function.

**Cooper Power Systems Arc Strangler® Switch**

Transformers may be equipped with either radial or loop-feed Arc Strangler switches mounted in the high-voltage compartment. These switches are equipped with current-limiting fuses. The Arc Strangler must be cocked before a switch or fuse assembly can be closed. Follow the Cooper Power Systems instructions for operating these devices. The load-break function is provided by either fuses or blades.

**S&C Pad-Mounted Gear**

When S&C air switches or fused disconnects are used, follow the manufacturer's instructions for operation. When operated with the S&C loadbuster tool, these disconnects function as loadbreak switches.



**WARNING:** Use the S&C loadbuster tool to operate the switch or fused disconnect. Failure to comply may result in serious personal injury or death.

**REQUIRED FORMS  
CHECKLIST**

The following forms are to be submitted as a part of the Bid/RFP/RFQ document

NAME	FORM DESCRIPTION	SUBMITTED WITH BID	
		YES	NO
Legal Notice	Acknowledgement Form	<input type="checkbox"/>	<input type="checkbox"/>
	Debarment Certification	<input type="checkbox"/>	<input type="checkbox"/>
	Ethics Statement	<input type="checkbox"/>	<input type="checkbox"/>
	Conflict of Interest Questionnaire	<input type="checkbox"/>	<input type="checkbox"/>
	W9 or W8 Form	<input type="checkbox"/>	<input type="checkbox"/>
	Direct Deposit Form (will be provided to the awarded vendor)	<input type="checkbox"/>	<input type="checkbox"/>
	Residence Certification Form	<input type="checkbox"/>	<input type="checkbox"/>
Special Instructions	Bid Schedule/Cost sheet completed and signed	<input type="checkbox"/>	<input type="checkbox"/>
	Cashier Check or Bid Bond of 5% of Total Amount of Bid (if applicable)	<input type="checkbox"/>	<input type="checkbox"/>
	OSHA 300 Log (if applicable)	<input type="checkbox"/>	<input type="checkbox"/>
	Contractor Pre-Bid Disclosure completed, signed and notarized (if applicable)	<input type="checkbox"/>	<input type="checkbox"/>
	Sub-Contractor Pre-Bid Disclosure completed, signed, and notarized (if applicable)	<input type="checkbox"/>	<input type="checkbox"/>
		<input type="checkbox"/>	<input type="checkbox"/>
References	Complete the Previous Customer Reference Worksheet for each reference provided	<input type="checkbox"/>	<input type="checkbox"/>
Addenda			

ETHICS STATEMENT

**(THIS FORM MUST BE COMPLETED IN ITS ENTIRETY AND SUBMITTED WITH BID RESPONSE)**

The undersigned bidder, by signing and executing this bid, certifies and represents to the Brownsville Public Utilities Board that bidder has not offered, conferred or agreed to confer any pecuniary benefit, as defined by (1.07 (a) (6) of the Texas Penal Code, or any other thing of value as consideration for the receipt of information or any special treatment of advantage relating to this bid; the bidder also certifies and represents that the bidder has not offered, conferred or agreed to confer any pecuniary benefit or other thing of value as consideration for the recipient's decision, opinion, recommendation, vote or other exercise of discretion concerning this bid, the bidder certifies and represents that bidder has neither coerced nor attempted to influence the exercise of discretion by any officer, trustee, agent or employee of the Brownsville Public Utilities Board concerning this bid on the basis of any consideration not authorized by law; the bidder also certifies and represents that bidder has not received any information not available to other bidders so as to give the undersigned a preferential advantage with respect to this bid; the bidder further certifies and represents that bidder has not violated any state, federal, or local law, regulation or ordinance relating to bribery, improper influence, collusion or the like and that bidder will not in the future offer, confer, or agree to confer any pecuniary benefit or other thing of value of any officer, trustee, agent or employee of the Brownsville Public Utilities Board in return for the person having exercised their person's official discretion, power or duty with respect to this bid; the bidder certifies and represents that it has not now and will not in the future offer, confer, or agree to confer a pecuniary benefit or other thing of value to any officer, trustee, agent, or employee of the Brownsville Public Utilities Board in connection with information regarding this bid, the submission of this bid, the award of this bid or the performance, delivery or sale pursuant to this bid.

**THE BIDDER SHALL DEFEND, INDEMNIFY, AND HOLD HARMLESS THE BROWNSVILLE PUBLIC UTILITIES BOARD, ALL OF ITS OFFICERS, AGENTS AND EMPLOYEES FROM AND AGAINST ALL CLAIMS, ACTIONS, SUITS, DEMANDS, PROCEEDING, COSTS, DAMAGES, AND LIABILITIES, ARISING OUT OF, CONNECTED WITH, OR RESULTING FROM ANY ACTS OR OMISSIONS OF CONTRACTOR OR ANY AGENT, EMPLOYEE, SUBCONTRACTOR, OR SUPPLIER OF CONTRACTOR IN THE EXECUTION OR PERFORMANCE OF THIS BID.**

I have read all of the specifications and general bid requirements and do hereby certify that all items submitted meet specifications.

COMPANY: \_\_\_\_\_  
AGENT NAME: \_\_\_\_\_  
AGENT SIGNATURE: \_\_\_\_\_  
ADDRESS: \_\_\_\_\_  
CITY: \_\_\_\_\_  
STATE: \_\_\_\_\_ ZIP CODE: \_\_\_\_\_  
TELEPHONE: \_\_\_\_\_ TELEFAX: \_\_\_\_\_  
FEDERAL ID#: \_\_\_\_\_ AND/OR SOCIAL SECURITY #: \_\_\_\_\_

**DEVIATIONS FROM SPECIFICATIONS IF ANY:**

---

NOTE: QUESTIONS AND CONCERNS FROM PROSPECTIVE CONTRACTORS SHOULD BE RAISED WITH OWNER AND ITS CONSULTANT (IF APPLICABLE) AND RESOLVED IF POSSIBLE, PRIOR TO THE BID SUBMITTAL DATE. ANY LISTED DEVIATIONS IN A FINALLY SUBMITTED BID MAY ALLOW THE OWNER TO REJECT A BID AS NON-RESPONSIVE.

---

**CERTIFICATION REGARDING DEBARMENT, SUSPENSION, AND OTHER RESPONSIBILITY MATTERS (THIS FORM MUST BE COMPLETED IN ITS ENTIRETY AND SUBMITTED WITH BID RESPONSE)**

Name of Entity: \_\_\_\_\_

The prospective participant certifies to the best of their knowledge and belief that they and their principals:

- a) Are not presently debarred, suspended, proposed for debarment, declared ineligible, or voluntarily excluded from covered transactions by any Federal department or agency;
- b) Have not within a three year period preceding this bid been convicted of or had a civil judgment rendered against them for commission of fraud or a criminal offense in connection with obtaining, attempting to obtain, or performing a public (Federal, State, or Local) transaction or contract under a public transaction; violation of Federal or State antitrust statutes or commission of embezzlement, theft, forgery, bribery, falsification or destruction of records, making false statements, or receiving stolen property;
- c) Are not presently indicted for or otherwise criminally or civilly charged by a government entity (Federal, State, Local) with commission of any of the offenses enumerated in paragraph (1) (b) of this certification; and
- d) Have not within a three year period preceding this application/bid had one or more public transactions (Federal, State, or Local) terminated for cause or default.

I understand that a false statement on this certification may be grounds for rejection of this bid or termination of the award. In addition, under 18 USC Section 1001, a false statement may result in a fine up to a \$10,000.00 or imprisonment for up to five (5) years, or both.

---

\_\_\_\_\_  
Name and Title of Authorized Representative (Typed)

---

\_\_\_\_\_  
Signature of Authorized Representative

---

\_\_\_\_\_  
Date

---

**I am unable to certify to the above statements. My explanation is attached**

# FORM CIQ

**THIS FORM MUST BE COMPLETED IN ITS ENTIRETY AND SUBMITTED WITH PROPOSAL RESPONSE**

<b>CONFLICT OF INTEREST QUESTIONNAIRE</b> For vendor doing business with local governmental entity		<b>FORM CIQ</b>
<p>This questionnaire reflects changes made to the law by H.B. 23, 84th Leg., Regular Session.</p> <p>This questionnaire is being filed in accordance with Chapter 176, Local Government Code, by a vendor who has a business relationship as defined by Section 176.001(1-a) with a local governmental entity and the vendor meets requirements under Section 176.006(a).</p> <p>By law this questionnaire must be filed with the records administrator of the local governmental entity not later than the 7th business day after the date the vendor becomes aware of facts that require the statement to be filed. See Section 176.006(a-1), Local Government Code.</p> <p>A vendor commits an offense if the vendor knowingly violates Section 176.006, Local Government Code. An offense under this section is a misdemeanor.</p>	<b>OFFICE USE ONLY</b>  Date Received	
<b>1</b> Name of vendor who has a business relationship with local governmental entity.		
<b>2</b> <input type="checkbox"/> Check this box if you are filing an update to a previously filed questionnaire. (The law requires that you file an updated completed questionnaire with the appropriate filing authority not later than the 7th business day after the date on which you became aware that the originally filed questionnaire was incomplete or inaccurate.)		
<b>3</b> Name of local government officer about whom the information is being disclosed.	_____ Name of Officer	
<b>4</b> Describe each employment or other business relationship with the local government officer, or a family member of the officer, as described by Section 176.003(a)(2)(A). Also describe any family relationship with the local government officer. Complete subparts A and B for each employment or business relationship described. Attach additional pages to this Form CIQ as necessary.		
A. Is the local government officer or a family member of the officer receiving or likely to receive taxable income, other than investment income, from the vendor?		
<input type="checkbox"/> Yes <input type="checkbox"/> No		
B. Is the vendor receiving or likely to receive taxable income, other than investment income, from or at the direction of the local government officer or a family member of the officer AND the taxable income is not received from the local governmental entity?		
<input type="checkbox"/> Yes <input type="checkbox"/> No		
<b>5</b> Describe each employment or business relationship that the vendor named in Section 1 maintains with a corporation or other business entity with respect to which the local government officer serves as an officer or director, or holds an ownership interest of one percent or more.		
<b>6</b> <input type="checkbox"/> Check this box if the vendor has given the local government officer or a family member of the officer one or more gifts as described in Section 176.003(a)(2)(B), excluding gifts described in Section 176.003(a-1).		
<b>7</b>		
_____ Signature of vendor doing business with the governmental entity		_____ Date

**CONFLICT OF INTEREST QUESTIONNAIRE**  
**For vendor doing business with local governmental entity**

A complete copy of Chapter 176 of the Local Government Code may be found at <http://www.statutes.legis.state.tx.us/Docs/LG/htm/LG.176.htm>. For easy reference, below are some of the sections cited on this form.

**Local Government Code § 176.001(1-a):** "Business relationship" means a connection between two or more parties based on commercial activity of one of the parties. The term does not include a connection based on:

- (A) a transaction that is subject to rate or fee regulation by a federal, state, or local governmental entity or an agency of a federal, state, or local governmental entity;
- (B) a transaction conducted at a price and subject to terms available to the public; or
- (C) a purchase or lease of goods or services from a person that is chartered by a state or federal agency and that is subject to regular examination by, and reporting to, that agency.

**Local Government Code § 176.003(a)(2)(A) and (B):**

(a) A local government officer shall file a conflicts disclosure statement with respect to a vendor if:

\*\*\*

(2) the vendor:

(A) has an employment or other business relationship with the local government officer or a family member of the officer that results in the officer or family member receiving taxable income, other than investment income, that exceeds \$2,500 during the 12-month period preceding the date that the officer becomes aware that

- (i) a contract between the local governmental entity and vendor has been executed; or
- (ii) the local governmental entity is considering entering into a contract with the vendor;

(B) has given to the local government officer or a family member of the officer one or more gifts that have an aggregate value of more than \$100 in the 12-month period preceding the date the officer becomes aware that:

- (i) a contract between the local governmental entity and vendor has been executed; or
- (ii) the local governmental entity is considering entering into a contract with the vendor.

**Local Government Code § 176.006(a) and (a-1)**

(a) A vendor shall file a completed conflict of interest questionnaire if the vendor has a business relationship with a local governmental entity and:

- (1) has an employment or other business relationship with a local government officer of that local governmental entity, or a family member of the officer, described by Section 176.003(a)(2)(A);
- (2) has given a local government officer of that local governmental entity, or a family member of the officer, one or more gifts with the aggregate value specified by Section 176.003(a)(2)(B), excluding any gift described by Section 176.003(a-1); or
- (3) has a family relationship with a local government officer of that local governmental entity.

(a-1) The completed conflict of interest questionnaire must be filed with the appropriate records administrator not later than the seventh business day after the later of:

(1) the date that the vendor:

- (A) begins discussions or negotiations to enter into a contract with the local governmental entity; or
- (B) submits to the local governmental entity an application, response to a request for proposals or bids, correspondence, or another writing related to a potential contract with the local governmental entity; or

(2) the date the vendor becomes aware:

- (A) of an employment or other business relationship with a local government officer, or a family member of the officer, described by Subsection (a);
- (B) that the vendor has given one or more gifts described by Subsection (a); or
- (C) of a family relationship with a local government officer.



**BROWNSVILLE PUBLIC UTILITIES BOARD**  
**RESIDENCE CERTIFICATION**

In accordance with Art. 601g, as passed by the 1985 Texas Legislature, the following will apply. The pertinent portion of the Act has been extracted and is as follows:

Section 1. (a)

- (1) "Nonresident bidder" means a bidder whose principal place of business is not in this state, but excludes a contractor whose ultimate parent company or majority owner has its principal place of business in this state.
- (2) "Texas resident bidder " means a bidder whose principal place of business is in this state, and includes a contractor whose ultimate parent company or majority owner has its principal place of business in this state.

Section 1. (b)

The state or governmental agency of the state may not award a contract for general construction, improvements, services, or public works projects or purchases of supplies, materials or equipment to a nonresident bidder unless the nonresident's bid is lower than the lowest bid submitted by a responsible Texas resident bidder by the same amount that a Texas resident bidder would be required to underbid a nonresident bidder to obtain a comparable contract in the state in which the nonresident's principal place of business is located.

I certify that \_\_\_\_\_(Company Name) is a **resident Texas bidder** as defined in Art. 601g.

Signature: \_\_\_\_\_

Print Name: \_\_\_\_\_

I certify that \_\_\_\_\_(Company Name) is a **nonresident bidder** as defined in Art. 601g. and our principal place of business is:

\_\_\_\_\_  
(City and State)

Signature: \_\_\_\_\_

Print Name: \_\_\_\_\_



Form **W-8BEN-E**

(Rev. October 2021)  
Department of the Treasury  
Internal Revenue Service

**Certificate of Status of Beneficial Owner for  
United States Tax Withholding and Reporting (Entities)**

▶ For use by entities. Individuals must use Form W-8BEN. ▶ Section references are to the Internal Revenue Code.  
▶ Go to [www.irs.gov/FormW8BENE](http://www.irs.gov/FormW8BENE) for instructions and the latest information.  
▶ Give this form to the withholding agent or payer. Do not send to the IRS.

OMB No. 1545-1621

**Do NOT use this form for:**

- U.S. entity or U.S. citizen or resident . . . . . W-9
- A foreign individual . . . . . W-8BEN (Individual) or Form 8233
- A foreign individual or entity claiming that income is effectively connected with the conduct of trade or business within the United States (unless claiming treaty benefits) . . . . . W-8ECI
- A foreign partnership, a foreign simple trust, or a foreign grantor trust (unless claiming treaty benefits) (see instructions for exceptions) . . . W-8IMY
- A foreign government, international organization, foreign central bank of issue, foreign tax-exempt organization, foreign private foundation, or government of a U.S. possession claiming that income is effectively connected U.S. income or that is claiming the applicability of section(s) 115(2), 501(c), 892, 895, or 1443(b) (unless claiming treaty benefits) (see instructions for other exceptions) . . . . . W-8ECI or W-8EXP
- Any person acting as an intermediary (including a qualified intermediary acting as a qualified derivatives dealer) . . . . . W-8IMY

**Instead use Form:**

**Part I Identification of Beneficial Owner**

<b>1</b> Name of organization that is the beneficial owner	<b>2</b> Country of incorporation or organization
--	---

**3** Name of disregarded entity receiving the payment (if applicable, see instructions)

**4** Chapter 3 Status (entity type) (Must check one box only):

<input type="checkbox"/> Simple trust	<input type="checkbox"/> Tax-exempt organization	<input type="checkbox"/> Corporation	<input type="checkbox"/> Partnership
<input type="checkbox"/> Central Bank of Issue	<input type="checkbox"/> Private foundation	<input type="checkbox"/> Complex trust	<input type="checkbox"/> Foreign Government - Controlled Entity
<input type="checkbox"/> Grantor trust	<input type="checkbox"/> Disregarded entity	<input type="checkbox"/> Estate	<input type="checkbox"/> Foreign Government - Integral Part
	<input type="checkbox"/> International organization		

If you entered disregarded entity, partnership, simple trust, or grantor trust above, is the entity a hybrid making a treaty claim? If "Yes," complete Part III.  Yes  No

**5** Chapter 4 Status (FATCA status) (See instructions for details and complete the certification below for the entity's applicable status.)

<input type="checkbox"/> Nonparticipating FFI (including an FFI related to a Reporting IGA FFI other than a deemed-compliant FFI, participating FFI, or exempt beneficial owner).	<input type="checkbox"/> Nonreporting IGA FFI. Complete Part XII.
<input type="checkbox"/> Participating FFI.	<input type="checkbox"/> Foreign government, government of a U.S. possession, or foreign central bank of issue. Complete Part XIII.
<input type="checkbox"/> Reporting Model 1 FFI.	<input type="checkbox"/> International organization. Complete Part XIV.
<input type="checkbox"/> Reporting Model 2 FFI.	<input type="checkbox"/> Exempt retirement plans. Complete Part XV.
<input type="checkbox"/> Registered deemed-compliant FFI (other than a reporting Model 1 FFI, sponsored FFI, or nonreporting IGA FFI covered in Part XII). See instructions.	<input type="checkbox"/> Entity wholly owned by exempt beneficial owners. Complete Part XVI.
<input type="checkbox"/> Sponsored FFI. Complete Part IV.	<input type="checkbox"/> Territory financial institution. Complete Part XVII.
<input type="checkbox"/> Certified deemed-compliant nonregistering local bank. Complete Part V.	<input type="checkbox"/> Excepted nonfinancial group entity. Complete Part XVIII.
<input type="checkbox"/> Certified deemed-compliant FFI with only low-value accounts. Complete Part VI.	<input type="checkbox"/> Excepted nonfinancial start-up company. Complete Part XIX.
<input type="checkbox"/> Certified deemed-compliant sponsored, closely held investment vehicle. Complete Part VII.	<input type="checkbox"/> Excepted nonfinancial entity in liquidation or bankruptcy. Complete Part XX.
<input type="checkbox"/> Certified deemed-compliant limited life debt investment entity. Complete Part VIII.	<input type="checkbox"/> 501(c) organization. Complete Part XXI.
<input type="checkbox"/> Certain investment entities that do not maintain financial accounts. Complete Part IX.	<input type="checkbox"/> Nonprofit organization. Complete Part XXII.
<input type="checkbox"/> Owner-documented FFI. Complete Part X.	<input type="checkbox"/> Publicly traded NFFE or NFFE affiliate of a publicly traded corporation. Complete Part XXIII.
<input type="checkbox"/> Restricted distributor. Complete Part XI.	<input type="checkbox"/> Excepted territory NFFE. Complete Part XXIV.
	<input type="checkbox"/> Active NFFE. Complete Part XXV.
	<input type="checkbox"/> Passive NFFE. Complete Part XXVI.
	<input type="checkbox"/> Excepted inter-affiliate FFI. Complete Part XXVII.
	<input type="checkbox"/> Direct reporting NFFE.
	<input type="checkbox"/> Sponsored direct reporting NFFE. Complete Part XXVIII.
	<input type="checkbox"/> Account that is not a financial account.

**6** Permanent residence address (street, apt. or suite no., or rural route). **Do not use a P.O. box or in-care-of address** (other than a registered address).

City or town, state or province. Include postal code where appropriate.	Country
---	---------

**7** Mailing address (if different from above)

City or town, state or province. Include postal code where appropriate.	Country
---	---------